

FLOOR2GO

LAMINATE FLOORING CATALOGUE

2026



WELCOME

Floor-2-Go are pleased to present to you, our new laminate flooring catalogue for 2025, this is our most robust and high-quality product collection to date.

We pride ourselves on offering the highest quality products at the best possible prices to our valued customers. Floor-2-Go is recognised by leading outlets, and because of this we are proud and honoured to bring you a wide array of premium products with beautiful designs and diverse finishes. In this catalogue you will find plenty of accessories for your flooring needs as well.

We deliver throughout Ireland on a daily basis to our commercial customers. Our knowledgeable staff and informative website are available to assist you with any further information you require. We thank you for the support and commitment you have shown us throughout the years, and we will make every endeavour to continue to supply you with quality products at competitive prices.



Tel: **065 686 4635**

WhatsApp: **087 117 7873**

Mail: **sales@floor2go.ie**

Website: **www.floor2go.ie**

Address:

Collections Warehouse
Drewsborough
Scariff
Co. Clare
V94 62P5

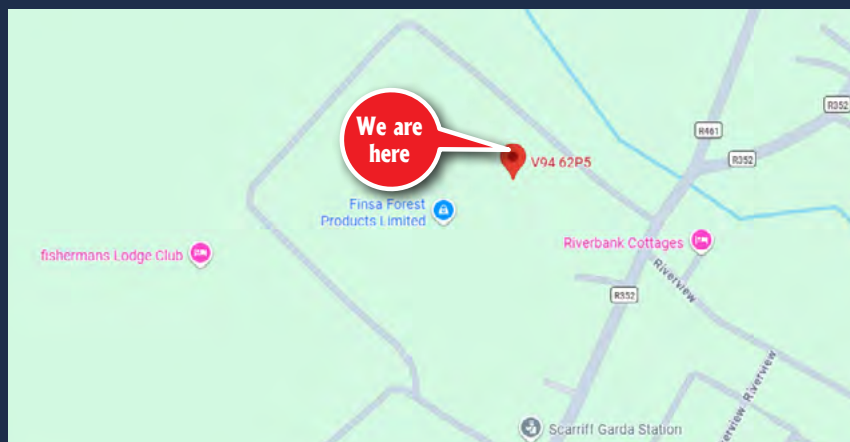

Office Address:

Floor2Go
Unit 2a, Clonroadmore
Business Park, Quin
Road, Ennis, Co. Clare,
V95 W63A

INDEX

Atlas Range 8mm	4-7	SPC Vinyl Flooring	46-50
Authentic Range 8mm	8-13	SPC Flooring Guidelines	51
Forest Range 12mm	14-22	Flooring Underlays	52-53
Forest Narrow Range 12mm	23-25	Marketing Material	54
Ocean Series 12mm	26-29	Mouldings	55-57
Authentic Range 12mm	30-31	Flooring Profiles	58-61
Nebraska Gloss Range 12mm	32-36	Legend	62
Herringbone Range 12mm	37-43	Returns & Complaints Policy	63
Laminate Flooring Guidelines	44	Terms & Conditions	64
Complaint Form	45		





8mm Atlas Bourbon Walnut

**NEW
RANGE**



ATLAS RANGE 8mm



PRODUCT DESCRIPTION



12mm: AC4

AC-4 Heavy Domestic Use
AC-4 Medium Commercial Use
Embossed Woodgrain Finish
20-Year Warranty



ATLAS BOURBON WALNUT 8mm AC-4/5G

Pallet: 60 Boxes / 2.89yd² pack (2.416 Mtrs) / 173.4yd² - (144.98 Mtrs)

Board Size: 1218 x 198 x 8mm

Boards Per Pack : 10pcs



ATLAS LIFFEY 8mm AC-4/5G

Pallet: 60 Boxes / 2.89yd² pack (2.416 Mtrs) / 173.4yd² - (144.98 Mtrs)

Board Size: 1218 x 198 x 8mm

Boards Per Pack : 10pcs



ATLAS DAVENPORT 8mm AC-4/5G

Pallet: 60 Boxes / 2.89yd² pack (2.416 Mtrs) / 173.4yd² - (144.98 Mtrs)

Board Size: 1218 x 198 x 8mm

Boards Per Pack : 10pcs



ATLAS SLANEY 8mm AC-4/5G

Pallet: 60 Boxes / 2.89yd² pack (2.416 Mtrs) / 173.4yd² - (144.98 Mtrs)

Board Size: 1218 x 198 x 8mm

Boards Per Pack : 10pcs



8mm Atlas Liffey

**NEW
RANGE**



8mm Atlas Davenport





**NEW
RANGE**

5G
Powered by Viking

**Blue
Bar**

8mm Atlas Slaney

8mm Authentic Rome





8mm Authentic Willow



AUTHENTIC RANGE 8mm



PRODUCT DESCRIPTION



8mm: AC5

AC-5 Heavy Domestic Use
AC-5 Medium Commercial Use
Embossed In Register Finish
30-Year Warranty



AUTHENTIC OAK 8mm AC5

Pallet: 60 x Boxes Pallet / 2.85yd² pack (2.38 Mtrs) / 171yd² pallet (143 Mtrs)

Board Size: 1215 x 195 x 8mm

Boards Per Pack : 10pcs



AUTHENTIC GENEVA 8mm AC5

Pallet: 60 x Boxes Pallet / 2.85yd² pack (2.38 Mtrs) / 171yd² pallet (143 Mtrs)

Board Size: 1215 x 195 x 8mm

Boards Per Pack : 10pcs

AUTHENTIC RANGE 8mm



PRODUCT DESCRIPTION



8mm: AC5

AC-5 Heavy Domestic Use
AC-5 Medium Commercial Use
Embossed In Register Finish
30-Year Warranty



AUTHENTIC ROME 8mm AC5

Pallet: 60 x Boxes Pallet /2.85yd² pack (2.38 Mtrs) / 171yd² pallet (143 Mtrs)

Board Size: 1215 x 195 x 8mm

Boards Per Pack : 10pcs



AUTHENTIC WILLOW 8mm AC5

Pallet: 60 x Boxes Pallet /2.85yd² pack (2.38 Mtrs) / 171yd² pallet (143 Mtrs)

Board Size: 1215 x 195 x 8mm

Boards Per Pack : 10pcs

8mm Authentic Oak





8mm Authentic Geneva



FOREST RANGE 12mm



PRODUCT DESCRIPTION



12mm: AC4
AC-4 Heavy Domestic Use
AC-4 Medium Commercial Use
Embossed In Register Finish
20-Year Warranty



FOREST MUNICH OAK AC-4/5G

Pallet: 50 Boxes / 2.29yds pack (1.92 Mtrs) / 114.50 yds - (95.74 Mtr)

Board Size: 1220x195 x 12mm

Boards Per Pack : 8pcs



FOREST HANOVER AC-4/5G

Pallet: 50 Boxes / 2.29yds pack (1.92 Mtrs) / 114.50 yds - (95.74 Mtr)

Board Size: 1220x195 x 12mm

Boards Per Pack : 8pcs



12mm Forest Hanover

12mm Forest Munich Oak



**NEW
RANGE**



FOREST RANGE 12mm



PRODUCT DESCRIPTION



12mm: AC4
AC-4 Heavy Domestic Use
AC-4 Medium Commercial Use
Embossed In Register Finish
20-Year Warranty



FOREST SHANNON OAK AC-4/5G

Pallet: 50 Boxes / 2.29yds pack (1.92 Mtrs) / 114.50 yds - (95.74 Mtr)

Board Size: 1220x195 x 12mm

Boards Per Pack : 8pcs



FOREST HONEY OAK AC-4/5G

Pallet: 50 Boxes / 2.29yds pack (1.92 Mtrs) / 114.50 yds - (95.74 Mtr)

Board Size: 1220x195 x 12mm

Boards Per Pack : 8pcs

12mm Forest Columbia



5G
Laminated by Vödinge

Blue Bar

12mm Forest Shannon Oak

NEW RANGE



FOREST RANGE 12mm



PRODUCT DESCRIPTION

12mm: AC4

AC-4 Heavy Domestic Use
AC-4 Medium Commercial Use
Embossed In Register Finish
20-Year Warranty



FOREST EMERALD OAK AC-4/5G

Pallet: 50 Boxes / 2.29yds pack (1.92 Mtrs) / 114.50 yds - (95.74 Mtr)

Board Size: 1220x195 x 12mm

Boards Per Pack : 8pcs

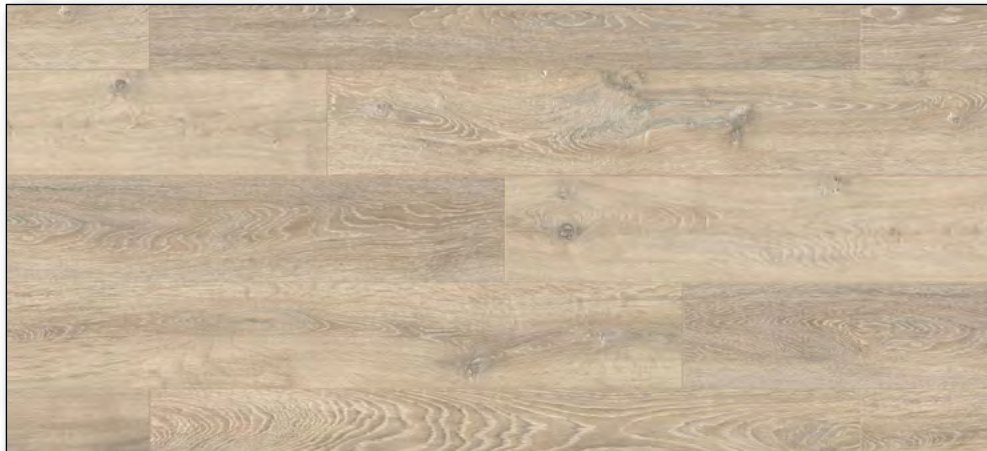

FOREST COLUMBIA OAK AC-4/5G

Pallet: 50 Boxes / 2.29yds pack (1.92 Mtrs) / 114.50 yds - (95.74 Mtr)

Board Size: 1220x195 x 12mm

Boards Per Pack : 8pcs



12mm Forest Emerald Oak

**NEW
RANGE**



12mm Forest Honey Oak



**NEW
RANGE**



12mm Oyster Oak



FOREST NARROW RANGE 12mm



PRODUCT DESCRIPTION



12mm: AC4

AC-4 Heavy Domestic Use
AC-4 Medium Commercial Use
Small Embossed Finish
20-Year Warranty

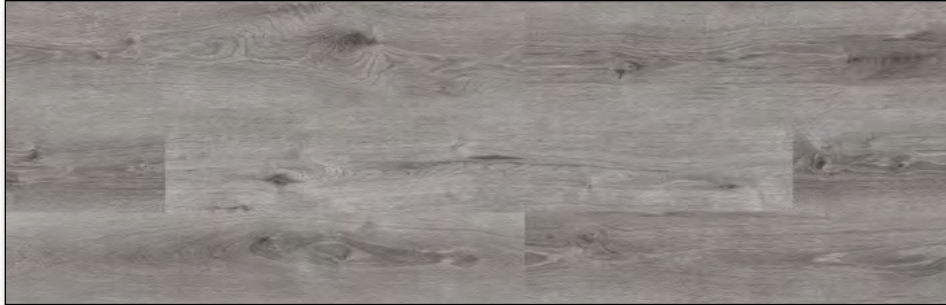

OYSTER GREY AC4

Pallet: 55 x Boxes Pallet /1.94yd² pack (1.63 Mtrs) - /106.7yd² pallet (89.21 Mtrs)

Board Size: 1220 x 165 x 12mm

Boards Per Pack: 8pcs



TUDOR OAK AC4

Pallet: 55 x Boxes Pallet /1.94yd² pack (1.63 Mtrs) - /106.7yd² pallet (89.21 Mtrs)

Board Size: 1220 x 165 x 12mm

Boards Per Pack: 8pcs



LOIRE AC4

Pallet: 55 x Boxes Pallet /1.94yd² pack (1.63 Mtrs) - /106.7yd² pallet (89.21 Mtrs)

Board Size: 1220 x 165 x 12mm

Boards Per Pack: 8pcs



12mm Rustic Walnut



OCEAN SERIES 12mm



PRODUCT DESCRIPTION



12mm: AC5/AC4
AC-5 Heavy Domestic Use
AC-5 Medium Commercial Use
Small Embossed Finish
30-Year Warranty

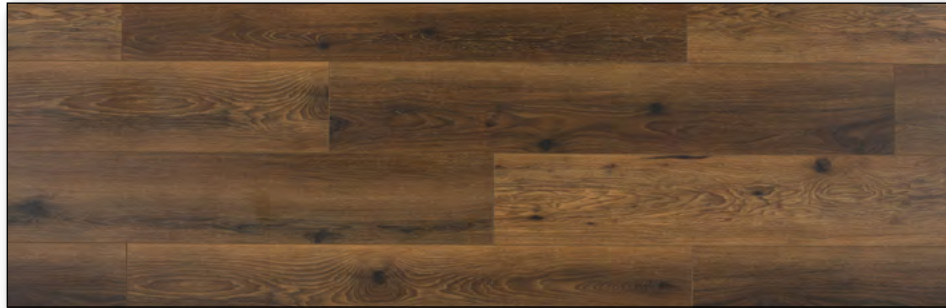

RUSTIC WALNUT AC5

Pallet: 50 x Boxes Pallet / 2.28yd² pack (1.90 Mtrs) - / 114yd² pallet (95.32 Mtrs)

Board Size: 1210 x 195 x 12mm

Boards Per Pack: 8pcs



RUSTIC OAK AC5

Pallet: 50 x Boxes Pallet / 2.28yd² pack (1.90 Mtrs) - / 114yd² pallet (95.32 Mtrs)

Board Size: 1210 x 195 x 12mm

Boards Per Pack: 8pcs

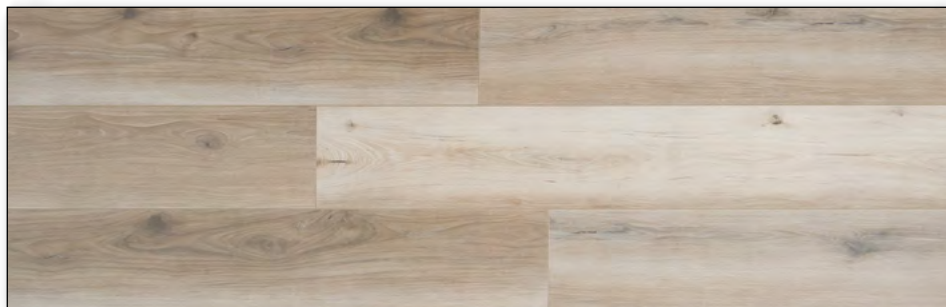

MOON AC4

Pallet: 50 x Boxes Pallet / 2.28yd² pack (1.90 Mtrs) - / 114yd² pallet (95.32 Mtrs)

Board Size: 1210 x 195 x 12mm

Boards Per Pack: 8pcs

AC
4

5G
Vollinge

12mm Moon



12mm Rustic Oak



OCEAN SERIES 12mm



PRODUCT DESCRIPTION

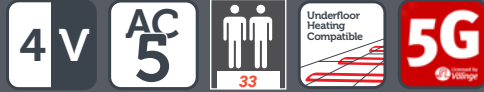

12mm: AC5

AC-5 Heavy Domestic Use
AC-5 Medium Commercial Use
Embossed In Register Finish
30-Year Warranty



BEIGE EIR AC5

Pallet: 50 x Boxes Pallet / 2.28yd² pack (1.90 Mtrs) - / 114yd² pallet (95.32 Mtrs)

Board Size: 1210 x 195 x 12mm

Boards Per Pack: 8pcs

12mm Beige EIR



AUTHENTIC RANGE 12mm



PRODUCT DESCRIPTION



12mm: AC5
AC-5 Heavy Domestic Use
AC-5 Medium Commercial Use
Embossed In Register Finish
30-Year Warranty



AUTHENTIC ROME AC5

Pallet: 50 x Boxes Pallet /2.29yd² pack (1.915 Mtrs) / 114.5yd² pallet (95.72 Mtrs)

Board Size: 1215 x 195 x 12mm

Boards Per Pack: 8pcs



AUTHENTIC WILLOW AC5

Pallet: 50 x Boxes Pallet /2.29yd² pack (1.915 Mtrs) / 114.5yd² pallet (95.72 Mtrs)

Board Size: 1215 x 195 x 12mm

Boards Per Pack: 8pcs



AUTHENTIC OAK AC5

Pallet: 50 x Boxes Pallet /2.29yd² pack (1.915 Mtrs) / 114.5yd² pallet (95.72 Mtrs)

Board Size: 1215 x 195 x 12mm

Boards Per Pack: 8pcs



AUTHENTIC GENEVA AC5

Pallet: 50 x Boxes Pallet /2.29yd² pack (1.915 Mtrs) / 114.5yd² pallet (95.72 Mtrs)

Board Size: 1215 x 195 x 12mm

Boards Per Pack: 8pcs



12mm Authentic Willow



NEBRASKA GLOSS 12mm



PRODUCT DESCRIPTION



12mm: AC3

AC3 Heavy Duty Domestic

12 Year Warranty

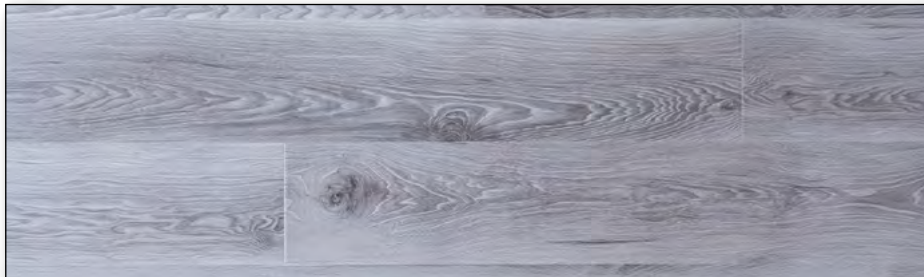

NEBRASKA SEATTLE GREY GLOSS AC3

Pallet: 45 x Boxes Pallet / 2.44yd² pack (2.04 Mtrs) / 109.8yd² pallet (91.8 Mtrs)

Board Size: 1218 x 167 x 12mm

Boards Per Pack: 10pcs

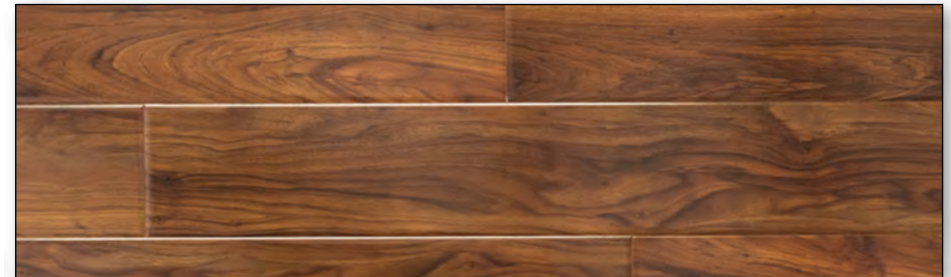

NEBRASKA CALGARY GLOSS AC3

Pallet: 45 x Boxes Pallet / 2.44yd² pack (2.04 Mtrs) / 109.8yd² pallet (91.8 Mtrs)

Board Size: 1218 x 167 x 12mm

Boards Per Pack: 10pcs

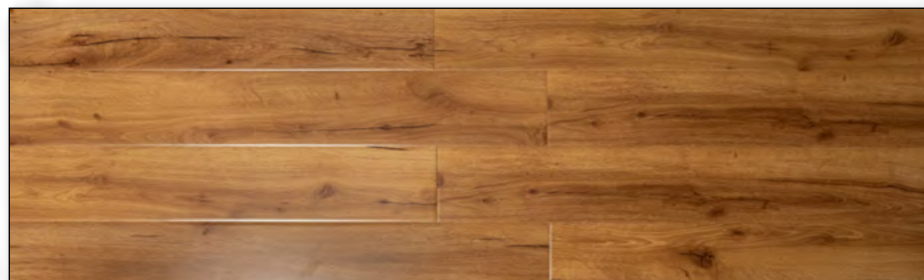

NEBRASKA ROME GLOSS AC3

Pallet: 45 x Boxes Pallet / 2.44yd² pack (2.04 Mtrs) / 109.8yd² pallet (91.8 Mtrs)

Board Size: 1218 x 167 x 12mm

Boards Per Pack: 10pcs

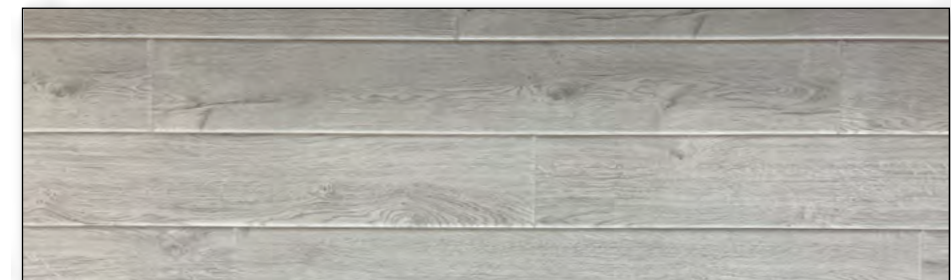

NEBRASKA ICE GLOSS AC3

Pallet: 45 x Boxes Pallet / 2.44yd² pack (2.04 Mtrs) / 109.8yd² pallet (91.8 Mtrs)

Board Size: 1218 x 167 x 12mm

Boards Per Pack: 10pcs





12mm Nebraska Rome Gloss



HERRINGBONE BAVARIAN 12mm



PRODUCT DESCRIPTION



12mm: AC4

AC-4 Heavy Domestic Use
AC-4 Medium Commercial Use
Embossed In Register Finish
20-Year Warranty



HERRINGBONE BAVARIAN AC4

Pallet: 48 x Boxes Pallet / 2.17yd² pack (1.81 Mtrs) / 104.16yd² pallet (86.80 Mtrs)

Board Size: 600 x 95 x 12mm

Boards Per Pack: 30

A & B Boards Mixed In Each Box

HERRINGBONE EIR RANGE 12mm



PRODUCT DESCRIPTION

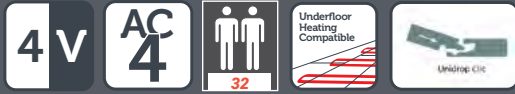

12mm: AC4

AC-4 Heavy Domestic Use
AC-4 Medium Commercial Use
Embossed In Register Finish
20-Year Warranty



HERRINGBONE SAND AC4

Pallet: 50 x Boxes Pallet / 2.31yd² pack (1.93 Mtrs) / 115.50yd² pallet (96.25 Mtrs)

Board Size: 600 x 100 x 12mm

Boards Per Pack: 32

A & B Boards Mixed In Each Box



HERRINGBONE EIR RANGE 12mm



PRODUCT DESCRIPTION



12mm: AC4

AC-4 Heavy Domestic Use
AC-4 Medium Commercial Use
Embossed In Register Finish
20-Year Warranty



HERRINGBONE SEATTLE GREY AC4

Pallet: 48 x Boxes Pallet / 2.31yd² pack (1.93 Mtrs) / 110.88yd² pallet (92.71 Mtrs)

Board Size: 600 x 100 x 12mm

Boards Per Pack: 32

A & B Boards Mixed In Each Box



HERRINGBONE EIR RANGE 12mm



PRODUCT DESCRIPTION



12mm: AC5

AC-5 Heavy Domestic Use
AC-5 Medium Commercial Use
Small Embossed Finish
30-Year Warranty



HERRINGBONE BEIGE AC5

Pallet: 50 x Boxes Pallet / 2.31yd² pack (1.93 Mtrs) / 115.50yd² pallet (96.25 Mtrs)

Board Size: 600 x 100 x 12mm

Boards Per Pack: 32

A & B Boards Mixed In Each Box



HERRINGBONE EIR RANGE 12mm



PRODUCT DESCRIPTION



12mm: AC5

AC-5 Heavy Domestic Use
AC-5 Medium Commercial Use
Small Embossed Finish
30-Year Warranty



HERRINGBONE MOON AC5

Pallet: 27 x Boxes Pallet / 2.76yd² pack (2.31Mtrs) / 74.52yd² pallet (62.31 Mtrs)

Board Size: 808 x 142 x 12mm

Boards Per Pack: 20

A & B Boards Mixed In Each Box



HERRINGBONE EIR RANGE 12mm



PRODUCT DESCRIPTION



12mm: AC5

AC-5 Heavy Domestic Use
AC-5 Medium Commercial Use
Small Embossed Finish
30-Year Warranty

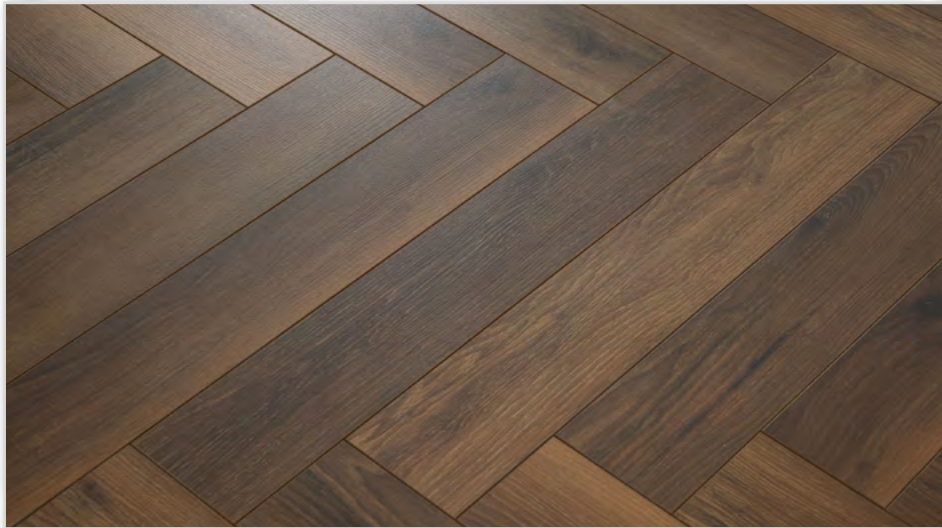

HERRINGBONE RUSTIC WALNUT AC5

Pallet: 48 x Boxes Pallet / 2.31yd² pack (1.93 Mtrs) / 110.88yd² pallet (92.71 Mtrs)

Board Size: 600 x 100 x 12mm

Boards Per Pack: 32

A & B Boards Mixed In Each Box

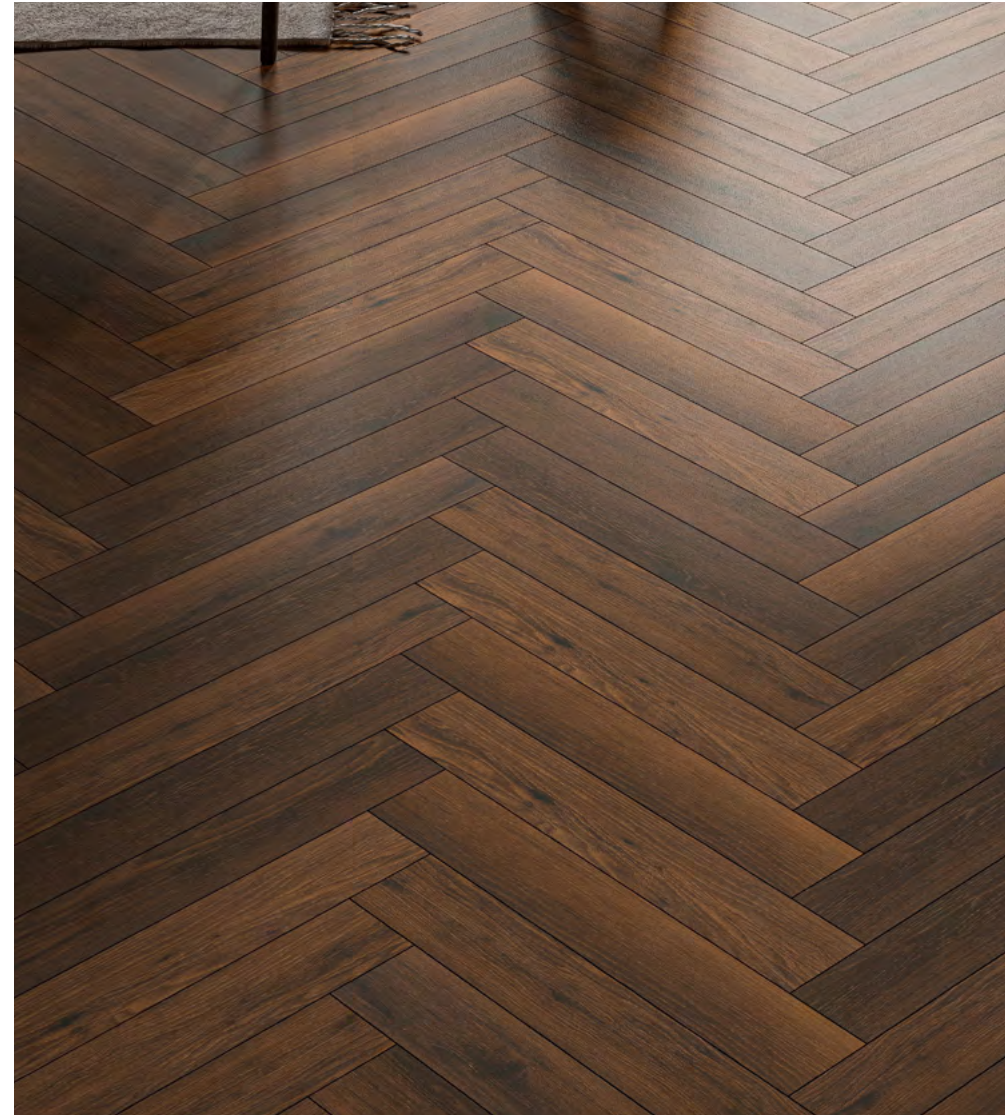

HERRINGBONE EIR RANGE 12mm



PRODUCT DESCRIPTION



12mm: AC5

AC-5 Heavy Domestic Use
AC-5 Medium Commercial Use
Small Embossed Finish
30-Year Warranty



HERRINGBONE RUSTIC OAK AC5

Pallet: 48 x Boxes Pallet / 2.31yd² pack (1.93 Mtrs) / 110.88yd² pallet (92.71 Mtrs)

Board Size: 600 x 100 x 12mm

Boards Per Pack: 32

A & B Boards Mixed In Each Box



GUIDELINES/CHECK LIST WHEN INSTALLING LAMINATE FLOORING

SITE CONDITIONS

- 1. HUMIDITY LEVELS** - Between 45% + 65%
- 2. ALLOWABLE MOISTURE CONTENT** - Concrete Subfloors or Timber Sub Floors should have a Moisture Content of 3% or Below
- 3. SUB-FLOOR LEVELS** - Should not be more than 3mm over a 1m distance in any direction.

FLOORING ACCLIMATISATION

- 1. 48HR ACCLIMATISATION-** Store your Laminate floors for 48Hrs in un-opened Boxes flat on the ground in the room the floor is being laid. Living conditions in the room should be normal with the Heating on.
- 2. UNDERFLOOR HEATING** - Ensure each pack of flooring is resting flat on the ground Separately.
- 3. INCORRECT CONDITIONS** - Your Floor will not acclimatise if the room is cold or if wet trades are being carried out such as painting or plastering.
 - ONCE ACCLIMATISED YOUR LAMINATE FLOOR MAY EXPAND OR SHRINK SLIGHTLY.
 - IT IS NOT UNCOMMON TO SEE BOWING IN EACH PLANK. THIS IS NOT A DEFECT.
 - IT IS THE HDF CORE ACCLIMATING TO THE HEAT + HUMIDITY OF THE ROOM.

EXPANSION JOINTS

- 1. 10MM-** A metre of laminate flooring can undergo dimensional fluctuations of about a millimetre. This is why it is critical to leave 10mm expansion gap around walls, door frames, stairs, pipes so forth.
- 2. EXPANSION JOINTS BETWEEN ROOMS-** This is absolutely essential. Room Humidity can vary owing to different heat conditions, etc. We therefore recommend that expansion joints are used under the doors between rooms.
- 3. EXPANSION JOINTS IN LARGE ROOMS-** If a room is more than **8M wide and/or 12M Long**, additional expansion joints are required. If a room is over 25m long several expansion joints will be necessary.
- 4. HEAVY OBJECTS-** Do not rest Heavy Objects on top of your Laminate floor. Max allowable weight 200kg.

These objects include:

- * Island Units
- * Kitchen Units
- * Grand Piano
- * Fireplaces

Failure to adhere to above will restrict movement and most likely cause issues with peaking.

UNFORTUNATELY IF CONDITIONS LAID OUT ABOVE ARE NOT ADHERED TO WE WILL NOT BE ABLE TO ENTERTAIN ANY CLAIMS THAT ARISE FROM YOUR FLOOR INSTALLATION.

Complaint Form

To Process your claim as quickly as possible, please complete the following questions. It is important you answer ALL sections. You can post complaint form to the following address: J&A Flooring Ltd t/a Floor2Go, Unit 2, Clonroadmore Business Park, Quinn Road, Ennis, Co.Clare, V95 W63A or forward complaint form to our e-mail at sales@floor2go.ie. Office telephone - 065 6864635 Office WhatsApp: 087 117 7873

Retailers Details

Name		Telephone	
Address			

Product Details

Product Range		Colour/Décor	
Area Installed M2/Yards2		Date Problem Started	
Date Installed		Fitters Name & Tel:	
Room laminate is fitted in			

Reason For Complaint

Describe in as much details as possible the problem/reason for complaint

Were boards acclimatised?	
If Yes please state where and for how long?	
Type of subfloor over which flooring was laid	
Has a damp proof been used?	
Is underfloor heating fitted, if so state what type including underlay used ?	
How much of an expansion gap has been left around edges?	
Have expansion profiles been used where appropriate?	
Have all boards staggered correctly by a minimum of 200mm?	
Describe how the floor has been cleaned?	

Please email images of complaint: sales@floor2go.ie or WhatsApp: 087 117 7873

DOWNLOAD A COPY OF THE FORM ON OUR WEBSITE WWW.FLOOR2GO.IE

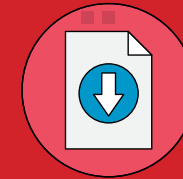

The Floor2go Sales Manager must be accompanied by retail staff member to view issues

Sales Manager: Alan Gough
Tel: 0873179902

Email: agough1971@gmail.com

Send images of the complaint to sales@floor2go.ie

or

Office WhatsApp: 087 117 7873

SPC VINYL FLOORING

Mediterranean Oak SPC



Mediterranean Oak Herringbone SPC



SPC VINYL FLOORING

PLANK RANGE

Product Depth – 4mm

Wear Layer – 0.5mm

TXPE – 1.0mm

Total Depth – 5.5mm



MEDITERRANEAN OAK SPC (4.5+1MM)

Pallet: 55 Boxes / 2.14yds pack (1.78 Mtrs) / 1117.70 yds - (97.90 Mtr)

Board Size: 1220x182 x 5.5mm

Boards Per Pack: 8pcs



PACIFIC BEIGE SPC (4.5+1MM)

Pallet: 55 Boxes / 2.14yds pack (1.78 Mtrs) / 1117.70 yds - (97.90 Mtr)

Board Size: 1220x182 x 5.5mm

Boards Per Pack: 8pcs

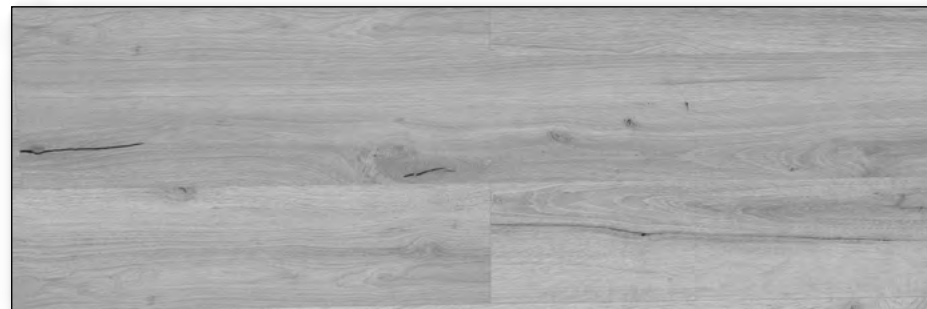

ATLANTIC GREY SPC (4.5+1MM)

Pallet: 55 Boxes / 2.14yds pack (1.78 Mtrs) / 1117.70 yds - (97.90 Mtr)

Board Size: 1220x182 x 5.5mm

Boards Per Pack: 8pcs

SPC VINYL FLOORING

Pacific Beige SPC



Pacific Beige Herringbone SPC



SPC VINYL FLOORING

HERRINGBONE RANGE

Product Depth – 4mm

Wear Layer – 0.5mm

TXPE – 1.0mm

Total Depth – 5.5mm



HERRINGBONE MEDITERRANEAN OAK SPC (4.5+1MM)

Pallet: 84 Boxes / 1.38yds pack (1.15 Mtrs) / 115.92 yds - (96.60 Mtr)

Board Size: 640x128 x **5.5mm**

Boards Per Pack: 14pcs



HERRINGBONE PACIFIC BEIGE SPC (4.5+1MM)

Pallet: 84 Boxes / 1.38yds pack (1.15 Mtrs) / 115.92 yds - (96.60 Mtr)

Board Size: 640x128 x **5.5mm**

Boards Per Pack: 14pcs

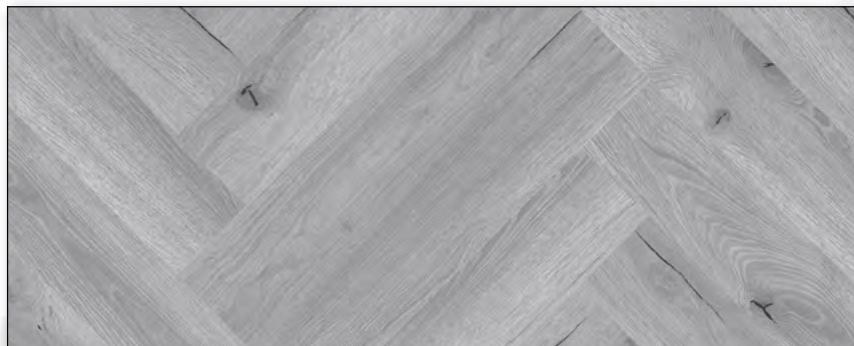

HERRINGBONE ATLANTIC GREY SPC (4.5+1MM)

Pallet: 84 Boxes / 1.38yds pack (1.15 Mtrs) / 115.92 yds - (96.60 Mtr)

Board Size: 640x128 x **5.5mm**

Boards Per Pack: 14pcs

SPC VINYL FLOORING

Atlantic Grey Herringbone SPC



Atlantic Grey SPC



SPC FLOORING GENERAL

WHAT IS SPC FLOORING - SPC Flooring means Stone Plastic Composite. It is composed of a rigid core layer made from a blend of natural Limestone powder, Polyvinyl Chloride, and stabilizers.

HOW RESISTANT IS SPC FLOORING - SPC Flooring is highly resistant to scratches and dents, capable to withstanding heavy foot traffic and significant Loads.

It is however susceptible to sharp or heavy objects if dropped.

UNDERFLOOR HEATING - SPC Flooring can be used safely with underfloor heating. Please note the maximum temperature should not exceed 27 Degrees Centigrade Water based electric heating systems

should be at 20 degree centigrade for a minimum of 1 week prior to installation.

SPC can be used with electric underfloor heating system. The heat source must be a minimum of 15mm away from the SPC Panels.

CONSERVATORY/SUNROOM - SPC Flooring is not recommended for installation in Sunrooms or Conservatories.

WATER RESISTANCE - SPC Flooring is **Highly Water Resistant**, however, prolonged or excessive exposure to moisture/humidity may affect the product.

FLOORING ACCLIMATISATION

1. 48HR ACCLIMITATISATION- Store your SPC floors for 48Hrs. The flooring should be acclimated and installed in a temperature controlled environment, with temperature fluctuations only permitted after the installation is complete.

2. UNDERFLOOR HEATING - Ensure each pack of flooring is resting flat on the ground Separately.

SUBFLOOR PREPERATION

It is essential that the floor is smooth. Any protrusions will need to be sanded. All hollows and gaps will need to be filled. The tolerance for the Sub Floor is 5mm over a span of 3m or 3mm over a span of 2m.

New Concrete Floors must cure + dry for a minimum of 60 days prior to prior to installation of SPC Flooring.

EXPANSION JOINTS

1. 8MM- A minimum of 8mm expansion gap is required in all areas, at all vertical surfaces to the floor.

2. EXPANSION JOINTS BETWEEN ROOMS- This is absolutely essential. Room Humidity can vary owing to different heat conditions, etc. We therefore recommend that expansion joints are used under the doors between rooms.

3. EXPANSION JOINTS IN LARGE ROOMS- If a room is more than **8M wide and/or 12M Long**, additional expansion joints are required. If a room is over 25m long several expansion joints will be necessary.

FLOORING UNDERLAYS



NEW

RUBBER GOLD ULTRA 3MM

Metres Per Roll: 10m

Roll Size: 3mm x 1m x 10m.

Tog Rating: 1.2

Decibel Rating: 23db

Underfloor Heating: No

Rolls Per Pallet: 40

Laminate Pallet: 8 Rolls on top

FLOORING UNDERLAYS



Metres Per Roll: 25m
Roll Size: 2mm x 1m x 25m
Tog Rating: 0.44
Decibel Rating: 15db
Underfloor Heating: No
Rolls Per Pallet: 24
Laminate Pallet: 6-8 Rolls on top



Metres Per Roll: 10m
Roll Size: 2mm x 1m x 10m
Tog Rating: 0.35
Decibel Rating: 20db
Underfloor Heating: Yes
Rolls Per Pallet: 50
Laminate Pallet: 10 Rolls on top



Metres Per Roll: 10m
Roll Size: 3mm x 1m x 10m
Tog Rating: 1.1
Decibel Rating: 22db
Underfloor Heating: No
Rolls Per Pallet: 48
Laminate Pallet: 10 Rolls on top



Metres Per Roll: 10m
Roll Size: 2mm x 1m x 10m
Tog Rating: 1.0
Decibel Rating: 23db
Underfloor Heating: No
Rolls Per Pallet: 50
Laminate Pallet: 10 Rolls on top



Metres Per Roll: 15m
Roll Size: 3mm x 1m x 15m
Tog Rating: 0.90
Decibel Rating: 19db
Underfloor Heating: No
Rolls Per Pallet: 24
Laminate Pallet: 6-8 Rolls on top



Metres Per Roll: 10m
Roll Size: 3mm x 1m x 10m
Tog Rating: 1.2
Decibel Rating: 23db
Underfloor Heating: No
Rolls Per Pallet: 40
Laminate Pallet: 10 Rolls on top

MARKETING MATERIAL

BOUTIQUE STYLE KIT OUT - TO YOUR REQUIRED SHOP DISPLAY MEASUREMENTS

PROFILE HANDBOARD



PROFILE STAND



SKIRTING/SCOTIA STAND



SKIRTING HANDBOARD



SAMPLE HANDBOARD STAND



MOULDINGS

PRE-FINISHED **LARGE** SCOTIA

NEW



EMERALD OAK SCOTIA

Code: Emerald

Size: 16x28x2400mm

30 Pcs Carton

NEW



MIAMI GREY SCOTIA

Code: Grey

Size: 16x28x2400mm

30 Pcs Carton



WHITE SCOTIA

Code: White

Size: 16x28x2400mm

30 Pcs Carton



BEIGE SCOTIA

Code: Beige

Size: 16x28x2400mm

30 Pcs Carton

MOULDINGS

PRE-FINISHED **SMALL SCOTIA**

NEW



BEAG EMERALD OAK SCOTIA

Code: Emerald Beag

Size: 10x22x2400mm

50 Pcs Carton

NEW



BEAG MIAMI GREY SCOTIA

Code: Grey Beag

Size: 10x22x2400mm

50 Pcs Carton



BEAG WHITE SCOTIA

Code: White Beag

Size: 10x22x2400mm

50 Pcs Carton



BEAG BEIGE SCOTIA

Code: Beige Beag

Size: 10x22x2400mm

50 Pcs Carton

MOULDINGS

PRE-FINISHED SKIRTING

NEW



EMERALD OAK SKIRTING

Code: Oak Skirt

Size: 15x130x2400mm

10 Pcs Carton

NEW



MIAMI GREY SKIRTING

Code: Grey Skirt

Size: 15x130x2400mm

10 Pcs Carton



WHITE SKIRTING

Code: White Skirt

Size: 15x130x2400mm

10 Pcs Carton



BEIGE SKIRTING

Code: Beige Skirt

Size: 15x130x2400mm

10 Pcs Carton



MATT WHITE SKIRTING

Code: CFL 35

Size: 15x130x2400mm

10 Pcs Carton

FLAT PROFILES

(0-2MM HEIGHT DIFFERENTIAL)



FLAT COVER STRIP OAK

Code: FCS OAK 900

Size: **900mm / 3ft**

BOX QTY: 30

Code: FCS OAK 2700

Size: **2700mm / 9ft**

BOX QTY: 10



FLAT COVER STRIP WALNUT

Code: FCS WAL 900

Size: **900mm / 3ft**

BOX QTY: 30

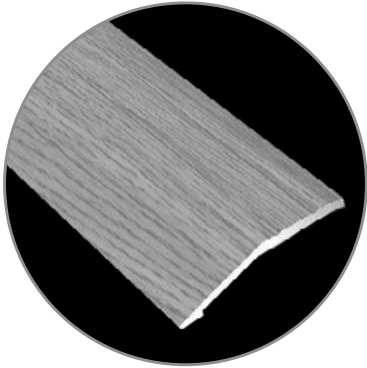

FLAT COVER STRIP GREY

Code: FCS Grey 900

Size: **900mm / 3ft**

BOX QTY: 30

Code: FCS GREY 2700

Size: **2700mm / 9ft**

BOX QTY: 10

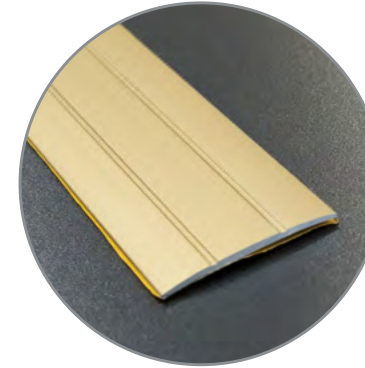

FLAT COVER STRIP GOLD

Code: FCS GOLD 900

Size: **900mm / 3ft**

BOX QTY: 30

Code: FCS GOLD 2700

Size: **2700mm / 9ft**

BOX QTY: 10

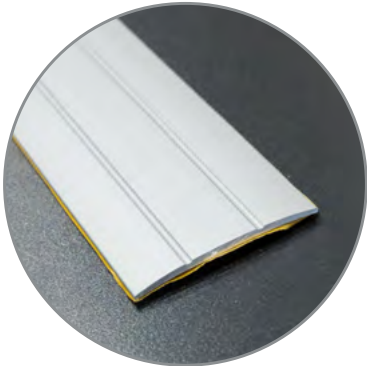

FLAT COVER STRIP CHROME MATT

Code: FCS CHROM 900

Size: **900mm / 3ft**

BOX QTY: 30

Code: FCS CHROM 2700

Size: **2700mm / 9ft**

BOX QTY: 10



FLAT COVER STRIP BEIGE

Code: FCS BGE 900

Size: **900mm / 3ft**

BOX QTY: 30

Code: FCS BGE 2700

Size: **2700mm / 9ft**

BOX QTY: 10

UNIVERSAL PROFILES

(3-12MM HEIGHT DIFFERENTIAL)



UNIVERSAL COVER STRIP OAK

Code: UNIV OAK 900

Size: **900mm / 3ft**

BOX QTY: 30

Code: UNIV OAK 2700

Size: **2700mm / 9ft**

BOX QTY: 10



UNIVERSAL COVER STRIP WALNUT

Code: UNIV WAL 900

Size: **900mm / 3ft**

BOX QTY: 30

Code: UNIV WAL 2700

Size: **2700mm / 9ft**

BOX QTY: 10

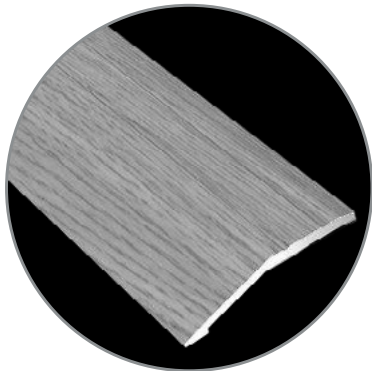

UNIVERSAL COVER STRIP GREY

Code: UNIV Grey 900

Size: **900mm / 3ft**

BOX QTY: 30

Code: UNIV Grey 2700

Size: **2700mm / 9ft**

BOX QTY: 10

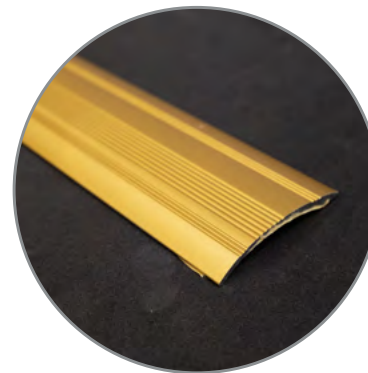

UNIVERSAL COVER STRIP GOLD MATT

Code: UNIV GOLD 900

Size: **900mm / 3ft**

BOX QTY: 30

Code: UNIV GOLD 2700

Size: **2700mm / 9ft**

BOX QTY: 10

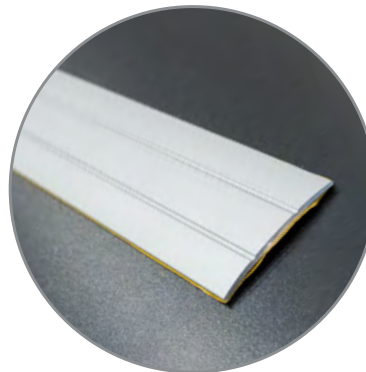

UNIVERSAL COVER STRIP CHROME MATT

Code: UNIV CHROM 900

Size: **900mm / 3ft**

BOX QTY: 30

Code: UNIV CHROM 2700

Size: **2700mm / 9ft**

BOX QTY: 10



UNIVERSAL COVER STRIP BEIGE

Code: UNIV BGE 900

Size: **900mm / 3ft**

BOX QTY: 30

Code: UNIV BGE 2700

Size: **2700mm / 9ft**

BOX QTY: 10

ANGLE EDGE PROFILES



ANGLE EDGE 8MM OAK

Code: ANGLE 900 OAK

Size: **900mm / 3ft**

BOX QTY: 30

Code: ANGLE 2700 OAK

Size: **2700mm / 9ft**

BOX QTY: 10

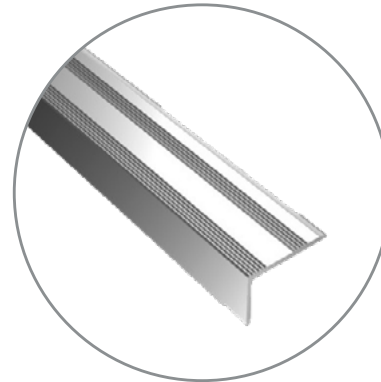

ANGLE EDGE 8MM CHROME

Code: ANGLE 900 CHRM

Size: **900mm / 3ft**

BOX QTY: 30

Code: ANGLE 2700 CHRM

Size: **2700mm / 9ft**

BOX QTY: 10

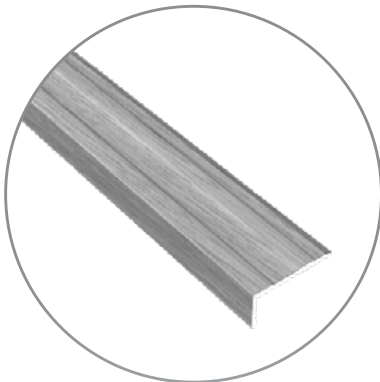

ANGLE EDGE 8MM GREY

Code: ANGLE 900 GREY

Size: **900mm / 3ft**

BOX QTY: 30

Code: ANGLE 2700 GREY

Size: **2700mm / 9ft**

BOX QTY: 10



ANGLE EDGE 8MM BEIGE

Code: ANGLE 900 BGE

Size: **900mm / 3ft**

BOX QTY: 30

Code: ANGLE 2700 BGE

Size: **2700mm / 9ft**

BOX QTY: 10

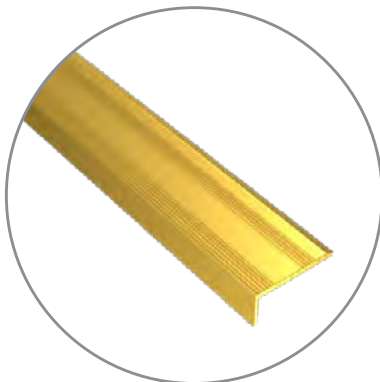

ANGLE EDGE 8MM GOLD

Code: ANGLE 900 GOLD

Size: **900mm / 3ft**

BOX QTY: 30

Code: ANGLE 2700 GOLD

Size: **2700mm / 9ft**

BOX QTY: 10

RAMP EDGE PROFILES



RAMP EDGE OAK

Code: RAMP 2700 OAK

Size: 2700mm / 9ft

BOX QTY: 10



RAMP EDGE CHROME

Code: RAMP 2700 CHRM

Size: 2700mm / 9ft

BOX QTY: 10



RAMP EDGE GREY

Code: RAMP 2700 GREY

Size: 2700mm / 9ft

BOX QTY: 10



RAMP EDGE BEIGE

Code: RAMP 2700 BGE

Size: 2700mm / 9ft

BOX QTY: 10



RAMP EDGE GOLD

Code: RAMP 2700 GOLD

Size: 2700mm / 9ft

BOX QTY: 10

LEGEND

WEAR RATING

All laminate floors resistance to wear is given as an abrasion class.

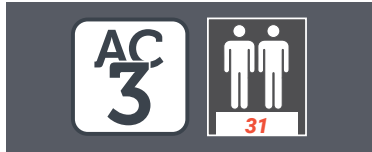

Suitable for light commercial and domestic everyday use.

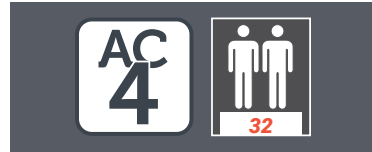

Suitable for medium traffic commercial & domestic everyday use.

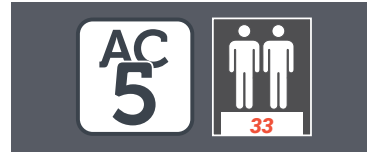

Suitable for high traffic commercial & everyday use.



4V GROOVE

V groove on all edges of board for natural plank appearance.

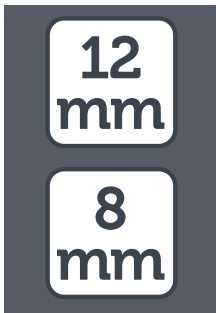

PRODUCT THICKNESS

Indicates overall thickness of board.



5G CLICK SYSTEM

Premium 5G click system makes the floor even easier to install.

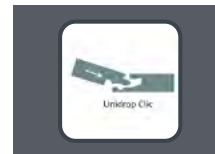

UNIDROP CLIC SYSTEM



UNDERFLOOR HEATING

Suitable for use with underfloor heating.

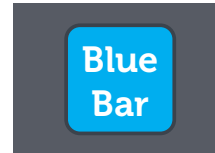

BLUE BAR



DROP LOCK

Simple push down secure click system.



VÄLINGE

RETURNS:

- All returns are subject to a 15% restocking fee plus any applicable freight charges.
- All discrepancies must be reported on the POD and alternatively reported within 48 hours.
- All goods for return must be inspected by our sales representative with invoice number provided prior to returns being accepted.
 - Open or damaged packs will not be accepted for return.
 - No special offers or discounted lines can be accepted for return.
- Once your return is approved and you have been issued a GRN docket please shrink wrap the goods on a pallet with relevant GRN paperwork with box labels visible. This is to allow our drivers to inspect and verify the goods before they are uplifted.
 - Items not approved on the GRN docket will not be collected.
- Once the items have been received by our warehouse your credit will be issued to your account in due course.

DAMAGES:

- Customer representative must check and sign for product at point of delivery.
- No claim of damage will be accepted under any circumstances on our behalf if POD is unsigned, signed “unchecked”, or signed as received in good condition.
- Claims for damages must be made with photographic evidence and a signed POD stating damage type and quantity within 24 hours of delivery by email or Whatsapp.
- In the event of goods being received in an unfit state, please keep ready for inspection / collection. • We cannot issue credits for goods that are not ready for inspection / collection.

MANUFACTURER’S LIABILITY:

Floor-2-Go’s liability for defective goods will be limited to replacement of goods to the equivalent value or a credit note to the value of goods damaged. We are not held liable for any subsequent loss or damage that occurs by the purchaser or customers of the purchaser. This is inclusive of lost time, damages when fitting, or other consequential losses. We are not liable for claims in respect of shortages in either width or length that fall within the normal manufacturing tolerance of 1.25%.

PLACING OF ORDERS:

Nothing in this price list should be deemed an offer, and we reserve the right to accept or refuse any order. Placing of an order implies acceptance of these trading terms and conditions.

ACCOUNTS:

- Should you wish to set up an account, you may request our Credit Application form by email, mail, or download it from our website. This can be returned by email or post.
 - All payments on account are paid on the agreed terms upon set up.
- It is our policy to place a hold on all overdue accounts. If any issues arise, please contact our accounts department (see back cover for contact details).

Placing an order implies acceptance of the Terms & Conditions herewith set out.

ORDERS AND DELIVERIES:

- Orders may be called in, emailed, or sent via the contact form on our website (see back for contact details).
- Order cut-off is 5 pm for next-day shipment. Courier delivery will be 24 to 48 hours after the day of shipment.
- Information given for date or time of delivery is given in good faith. However, the company cannot accept responsibility for any delays in delivery.
 - We do not deliver to residential addresses.

COLLECTION ORDERS:

- Collections must be booked in advance.
 - Orders placed before 11 am will be ready after 2 pm.
 - Orders placed between 11 am and 3 pm will be ready the next morning.
 - Orders placed after 3 pm will be ready the next day after 11 am.
- Persons collecting orders in our warehouse, must have a printed or WhatsApp sales order of the required order. This is to ensure the incorrect order is not given to customers with multiple orders on our system at one time.

DELIVERY CHARGES:

PALLETS

- Orders up to the pre-VAT value of €750 will incur a delivery cost up to €50.00 plus VAT. (€60 for Northern Ireland).
 - Orders at or above the pre-VAT value of €750 will have the delivery charge waived.

PARCEL DELIVERY

- For smaller items we offer a parcel delivery at a cost of €15.00 plus VAT per parcel. Maximum cost €30

NOTES

A series of 20 horizontal dotted lines for writing notes.

FLOOR2GO

where quality meets service

Office Sales: sales@floor2go.ie / 065 686 4635

Sales Manager: Alan Gough - 087 3179902 - agough1971@gmail.com

Accounts: Jean - jean@floor2go.ie

Unit 2 Clonroadmore Business Park, Quin Road, Ennis, Co. Clare, V95 W63A

Tel - 065 686 4635 Fax - 065 686 5652 Vat - 1113933UH